

MVE-SV "screen vibrators"



EX-STOCK DELIVERY
2 YEAR WARRANTY
SIZE 75A0 & 75D0
100% INTERCHANGEABLE
TO DERRICK® SCREEN
VIBRATORS FOOTPRINTS*



NO CROSSBEAM

Designed to be installed on vibrating screens and feeders without any support crossbeam



DIRECT VIBRATION

Designed to exert its centrifugal force much closer to the screen walls than traditional foot mounted electric vibrators fitted on a support crossbeam



ADJUSTABLE CF

Available with both adjustable or fixed masses

*Derrick® is a registered trademark of Derrick Corporation, Buffalo, New York. There is no affiliation between Derrick Corporation and OLI.



**VIBRATORS FOR
QUARRY & MINING,
OIL & GAS**





MVE-SV RANGE OVERVIEW



4 POLES EXPLOSION PROOF – 1500/1800 rpm

Ex II 2G: Temp. Class T4
Class I Div.1: Temp. Class T4
Ex II 2D Temp. Class: ● 135 °C

* Terminal Connections: Y High Voltage

Wm (kgcm)		Model		Centrifugal Force (kg)		Weight (kg)		ELECTRICAL SPECIFICATIONS							
								Input Power (kW)		Standard Nominal Current		* Terminal Connection	Ia / In (Ampere)		Cable Gland
50Hz	60Hz	50Hz	60Hz	50Hz	60Hz	50Hz	60Hz	50Hz (400V)	60Hz (460V)		50Hz		60Hz	Metric	
279	193	MVE 3500/15D-SV-75A0	MVE 3500/18D-SV-75A0	3,500	3,502	180	170	2.2	2.6	4.3	4.3	Y	6.5	6.5	3/4" NPT 110°C ●
279	193	MVE 3500/15D-SV-75D0	MVE 3500/18D-SV-75D0	3,500	3,502	180	170	2.2	2.6	4.3	4.3	Y	6.5	6.5	3/4" NPT 110°C ●
417	292	MVE 5300/15D-SV-80A0	MVE 5300/18D-SV-80A0	5,240	5,283	211	200	2.6	3.0	5.5	5.2	Y	7.1	7.0	3/4" NPT 110°C ●
620	434	MVE 8000/15D-SV-85A0	MVE 8000/18D-SV-85A0	7,790	7,851	280	260	3.2	3.8	6.3	6.3	Y	7.1	7.0	3/4" NPT 110°C ●

Model		Drawing	Size	DIMENSIONAL SPECIFICATIONS (mm)																
				C	M	A	A1	B	Ø G	Holes N°	D	E	F	H	I	L	L1	L2	L3	N
50Hz	60Hz																			
MVE 3500/15D-SV-75A0	MVE 3500/18D-SV-75A0	M	75A0	1,080	179	959	-	229	29	4	285	316	60	137	322	830	-	-	-	279
MVE 3500/15D-SV-75D0	MVE 3500/18D-SV-75D0	M	75D0	1,080	179	959	-	241	20	4	285	316	60	137	322	830	-	-	-	279
MVE 5300/15D-SV-80A0	MVE 5300/18D-SV-80A0	N	80A0	1,116	170	959	-	229	29	4	285	351	48	156	333	844	-	-	-	316
MVE 8000/15D-SV-85A0	MVE 8000/18D-SV-85A0	O	85A0	1,425	/	800	1,280	280	22	8	330	407	57	180	360	714	886	1,193	1,366	345

NOTE: The Model name in the standard range is different: the letter "D" changes in "N".

4 POLES STANDARD RANGE – 1500/1800 rpm



The MVE-SV is available also as "standard" range, with Ex II 3D certification: Ex II 3D Temp. Class: ● 135 °C
Electrical and dimensional specifications are the same as the "explosion proof" range.



- » II3D Ex tc IIIC Tx IP66
- » Equipment and protective system intended for use in potentially explosive atmospheres (Zone 22) - Directive 2014/34/UE
- » Compliance with Essential Health and Safety Requirements
- » EN 60079-0, EN 60079-31



- » Declaration of conformity "type B" according to: 2014/35/UE - 2006/42/EC - EN 60034-1
- » Conform to UL1446 and CSA 22.2 No 0-10



FEATURES

The SV electric motovibrator works like any other foot mounted electric model, providing vibrations to the vibrating machine on which it is installed. Two parallel SV are needed to provide **linear motion** to the vibrating machine while just one is necessary to provide **circular motion**.

The **SV do not need any crossbeam to be installed** because the body works as a crossbeam itself.

The SV size 75A0 and 75D0 are designed to retrofit existing vibrating machines using motorvibrator made by **Derrick® Screen Vibrators**. Thanks to its versatility, the SV range can also be used in many other applications:

QUARRY & MINING

- Wet and dry solids separation (eg "Stack Sizer" by Derrick®)
- Screening (eg "High speed screens" by Derrick®)

OIL & GAS

- Drilling fluids recovery systems (eg "Hyperpool" shale shakers by Derrick®)

ADVANTAGES OF SV RANGE

- OLI SV size 75A0 and 75D0 match both the Derrick®'s long vibrator footprints
- First class bearings
- Long bearing life
- Easy mass adjustment positions
- Greased for life, 100% maintenance free

APPLICATION ADVANTAGES

- The centrifugal force is provided directly on the screen walls, improving screening efficiency and screening mesh life span
- In OLI SV it is possible to adjust the centrifugal force using pre-drilled holes on the adjustable mass
- SV comes with a standard factory preset star connection for high voltage inside the terminal box
- OLI SV can also be operated at low voltage by simply changing the position of the connection plates inside the terminal box, switching from Star to Delta connection.
- SV can be supplied on request with multiple voltages suitable to be used in various countries all over the world

SV Size 75A0



SV Size 85A0



M

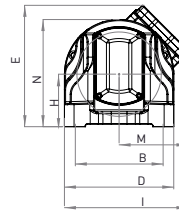
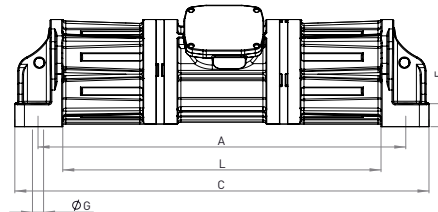

N

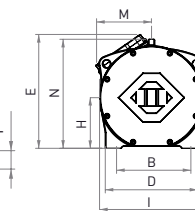
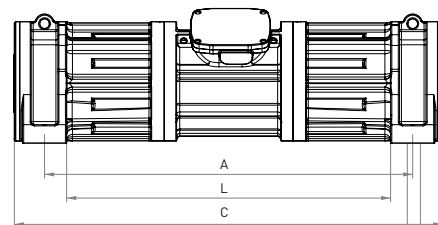

O

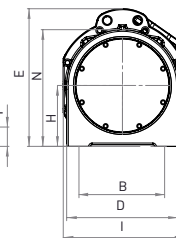
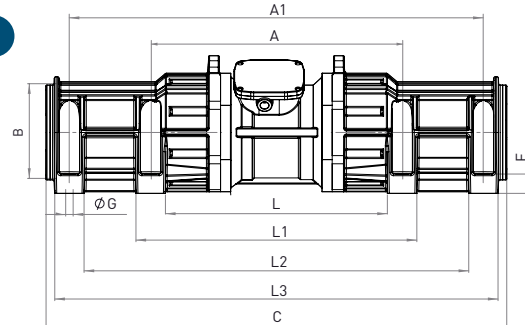

MVE-SV SCREEN VIBRATOR

APPLICATION Vibrating screens, shale shakers, feeders/conveyors and dewatering screens for quarry, mining, recycling and other sectors

PROBLEM SOLVING SV acts as a structural part of the machine: it eliminates the crossbeam usually needed to support standard vibrating motors. The centrifugal force is applied directly on the screen walls avoiding energy dissipation

FEATURES

INPUT VOLTAGE 220-240/380-415V, 290-300/500-525V (50Hz); 330/575V, 220-277/380-480V, 230/460V (60Hz)

AMBIENT TEMPERATURE -20 °C / +40 °C as standard, -20 °C / +55 °C on request

ENCLOSURE PROTECTION IP 66

THERMAL PROTECTION Thermistor PTC 130 °C included

INSULATION CLASS F

OPTIONS

2 and 6 poles available on request

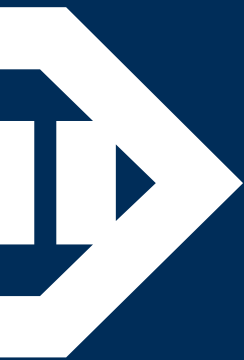

WHEN YOU NEED IT, WHERE YOU NEED IT

THE WORLDWIDE LEADER IN VIBRATION TECHNOLOGY



OLI WORLDWIDE

OLI Australia	OLI Korea	OLI South Africa
OLI Brazil	OLI Malaysia	OLI Spain
OLI China	OLI Malta	OLI Thailand
OLI France	OLI Mexico	OLI Turkey
OLI Germany	OLI Middle East	OLI UK
OLI India	OLI Nordic	OLI USA
OLI Indonesia	OLI Poland	OLI Vietnam
OLI Italy	OLI Russia	



OLI Headquarters

Via Sparato, 14
41036 Medolla (MO) - Italy

+39 0535 41 06 11

info@olivibra.com

WWW.OLIVIBRA.COM